

# 大口径マシンハッチ Zタイプ CHPL蓋

フロアーハッチ  
大口径マシンハッチ

ステンレス目地

一般型

歩道用

T-2

T-6

T-14

## BMH-ZCZ-1 BMH-ZCZ-2 BMH-ZCZ-6 BMH-ZCZ-14

蓋めっき  
受注生産

蓋めっき  
受注生産

蓋めっき  
受注生産

蓋めっき  
受注生産

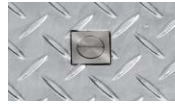
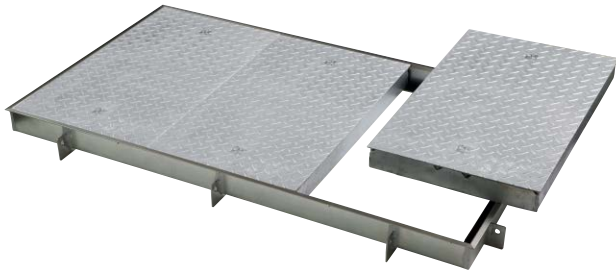

蓋めっき

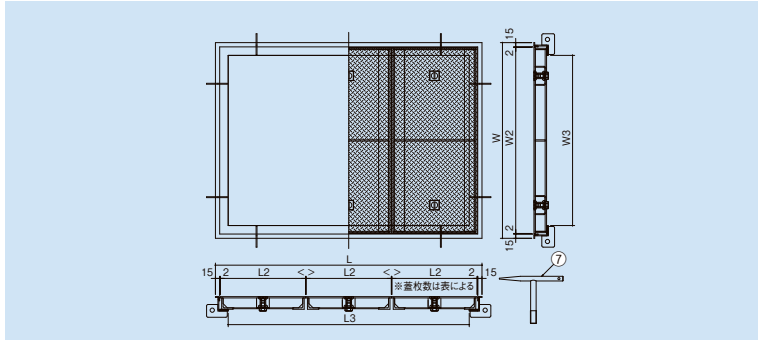

### ■断面詳細：A、B・納まり図

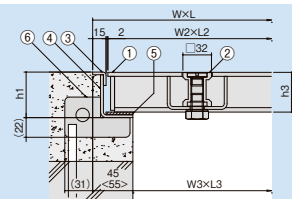

※<>寸法は、  
BMH-ZCZ-1 ...W3寸法1000を超える種  
BMH-ZCZ-2、6 ...W3寸法700を超える種  
BMH-ZCZ-14 ...全種

(単位：mm)

型式記号	呼称(開口)	価格(円)	枠外		蓋 1枚サイズ		h1	断面 詳細	蓋数	総質量 (Kg)
	W3×L3		W×L	W2×L2	h3					
BMH-ZCZ-1	600	172,400	690	656×656	44.5	51	A	1	29.4	
	650	188,000	740	706×706				1	32.9	
	700	208,200	790	756×377				2	41.2	
	750	222,300	840	806×402				2	45.2	
	800	229,500	890	856×427				2	49.3	
	850	255,300	940	906×452				2	53.8	
	900	248,700	990	956×477				2	58.5	
	950	272,000	1040	1006×502				2	63.1	
	1000	265,200	1090	1056×527				2	68.0	
	1050	287,400	1160	1126×562				2	83.3	
	1200	493,500	1310	1276×424				3	112.4	
	1500	726,600	1610	1576×393				4	171.0	
	600×1200	261,100	690×1290	656×418				3	57.0	
	600×1800	416,900	690×1890	656×463				4	80.5	
900×1500	547,200	990×1590	956×388	4	96.2					
1000×2000	678,600	1090×2090	1056×513	4	127.2					
BMH-ZCZ-2	600	292,200	690	656×656	44.5	51	A	1	35.1	
	700	298,000	790	756×377				2	49.8	
	800	300,400	910	876×437				2	62.1	
	900	327,200	1010	976×487				2	72.9	
	1000	355,100	1110	1076×537				2	110.0	
	1200	760,700	1310	1276×424				3	151.0	
	600×1200	311,400	690×1290	656×418				3	68.4	
	600×1800	437,600	690×1890	656×463				4	95.7	
	900×1500	753,600	1010×1610	976×393				4	122.3	
	1000×2000	1,044,500	1110×2110	1076×414				5	208.2	
BMH-ZCZ-6	600	298,800	690	656×656	69.5	76	A	1	42.3	
	700	317,500	790	756×377				2	64.1	
	800	384,200	910	876×437				2	89.1	
	900	406,700	1010	976×487				2	102.9	
	1000	422,900	1110	1076×537				2	131.8	
	1200	837,100	1310	637×637				4	179.1	
	600×1200	395,400	690×1290	656×418				3	75.5	
	600×1800	490,000	690×1890	656×463				4	116.8	
	900×1500	862,500	1010×1610	976×393				4	156.2	
	1000×2000	1,221,700	1110×2110	1076×414				5	243.3	
BMH-ZCZ-14	600	307,900	710	676×676	69.5	76	B	1	52.7	
	700	327,400	810	776×387				2	75.6	
	800	397,900	910	876×437				2	129.3	
	900	411,500	1010	976×487				2	148.5	
	1000	442,500	1110	1076×537				2	167.5	
	1200	898,000	1310	637×637				4	215.1	
	600×1200	446,600	710×1310	676×424				3	104.6	
	600×1800	563,700	710×1910	676×468				4	144.9	
	900×1500	1,083,900	1010×1610	976×393				4	216.1	
	1000×2000	1,415,300	1110×2110	1076×414				5	297.0	

### ■断面詳細：C

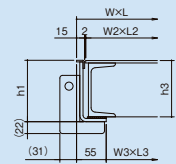

### ■断面詳細：D

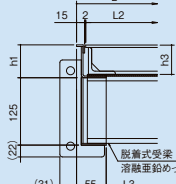

### ■断面詳細：E

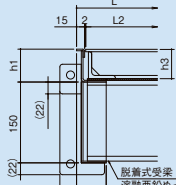

※受梁付  
●呼称600等は正方形、呼称600×1200等は長方形です。  
●型式例 [適用荷重T-2、開口900]の場合⇒[BMH-ZCZ-2-900]となります。

●掲載価格には、消費税が含まれておりません。



詳細情報

